

000262

50.02

03-98

- Ripple Fin® tubing
- Eurovent certified
- Selektion based on DT<sub>1</sub>
- Capacities for R 22, R 134a and R 404A

EUROVENT  
CERTIFIED PERFORMANCE



## *Blow Through* **Unit Coolers**

# LEX

*New air cooler generation with better performance*

**Capacities 1.5 - 40 kW**

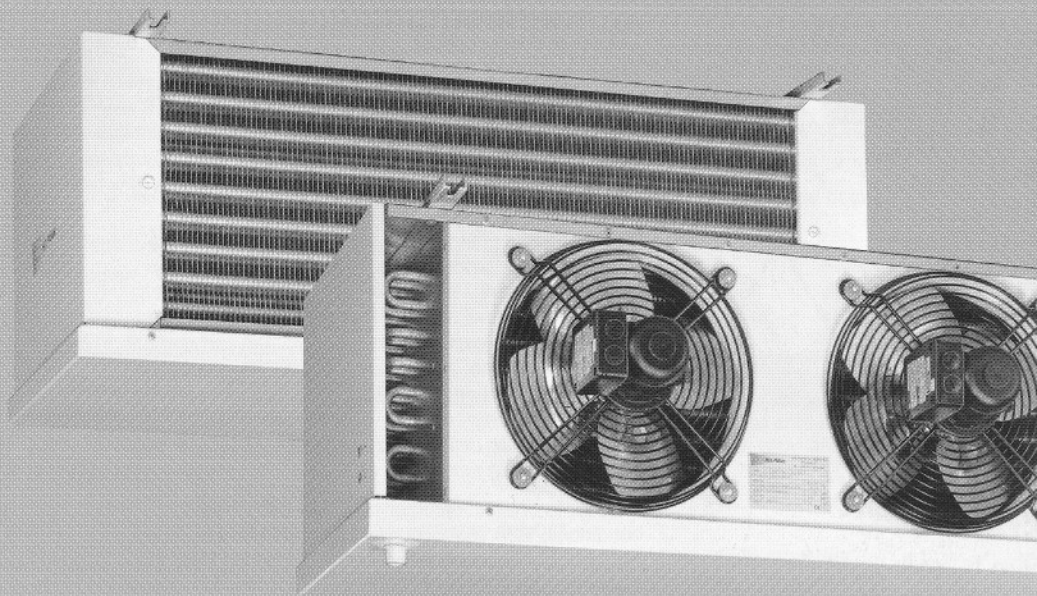

## HELPMAN

participant of the  
EUROVENT  
certification programme

## Blow Through Unit Coolers 1.5 - 40 kW

LEX

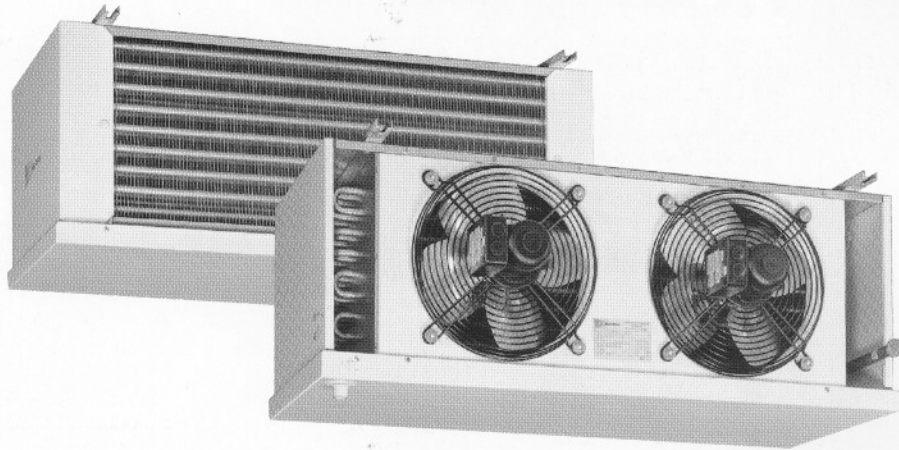
**Eurovent**

Within Europe, a wide variety of published data on capacities are in use, generally depending on national standards.

Most in use by the leading manufacturers are national and international standards like DIN, ENV, NEN and ASHRAE.

Due to this, customers have not been able to make objective product comparisons, since data published on capacities were based on DT<sub>1</sub>, DTM, dry or wet conditions, with or without certification, etc.

To meet the European requirements on EN standards, the European Refrigeration Industry embodied by Eurovent has set standards to guarantee an independent certification procedure for forced convection air cooled condensers based on ENV 327 and unit air coolers based on ENV 328. Being an active member of Eurovent, the capacities of the Helpman commercial cooler programme, as given in the technical documentation, are based on ENV 328.

(Evaporating temperature  $t_e = -8\text{ }^\circ\text{C}$ ,  
8 K temperature difference between air-on temperature and evaporating temperature DT<sub>1</sub>.)

In order to enable aircooler selection for operating conditions, technical documentation should also give capacities for humid/frosted conditions. According to Eurovent these 'frosted conditions' are to be calculated by multiplying 'dry capacities' with a factor 1.15. These data can be found in the capacity tables, in the columns "frosted conditions".

**CE Marking**

All coolers and condensers produced by Helpman comply with the EC Machinery Directive 89/392. In this respect all equipment is provided with extensive product information and a 2B Certificate.

CE-marking of complete cooling installations is obligatory as per 1 January 1995. The CE-marking support of Helpman cooling components therefore offers full service to refrigeration installers to meet the requirements on CE marking of cooling installations.

**DT<sub>1</sub>****Selection Example DT<sub>1</sub>**

|                           |        |
|---------------------------|--------|
| Selected cooler model     | LEX    |
| Selected fin spacing      | 7 mm   |
| Required cooling capacity | 6.8 kW |
| Air-on temperature        | -16 °C |
| Evaporating temperature   | -25 °C |
| Refrigerant               | R 22   |

*The calculation is based on the tables on page 4.*

- 1)  $DT_1 = -16 - (-25) = 9\text{ K}$
- 2) Correction factor (table) : 1.09
- 3) Multiply required capacity with correction factor :  
 $6.8\text{ kW} \times 1.09 = 7.4\text{ kW}$ .
- 4) A cooler has to be selected in column R 22, frosted DT<sub>1</sub>, with a nominal capacity of 7.4 kW.

For the above mentioned conditions a LEX 16 - 7 unit cooler with nominal capacity of 7.4 kW can be selected.

## Blow Through Unit Coolers 1.5 - 40 kW

LEX



## General

The LEX range of general purpose unit coolers consists of 30 basic models.  
Fin spacings 4 or 7 mm with 1 to 4 fans, blowing through the coil.  
Temperature application area + 5 °C to -35 °C.  
Capacity range 1.5 up to 40 kW.  
Suitable for all halocarbon refrigerants including R 22, R 134a and R 404A for use in cooling and freezing rooms.  
For general purpose coolers in draw through design see LZX. For air sock application see LXA.

## Type Indication

LEX 14 - 7 E / C - 220

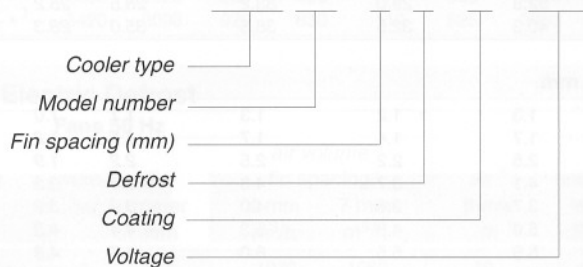

## Features

- Coil : copper Ripple Fin® tubing with aluminium fins. Fin thickness 0.35 mm. Tube diameter ½", tube wall thickness 0.40 mm. Tube centres 38 x 38 mm square pitch. Coils are pressure tested with dry air at 25 bar.
- Blow through design. Coil is air straightener; less turbulent air flow.
- Eflo® refrigerant circuiting for higher effective cooling capacity.
- Durable aluminium casing, white epoxy coated, RAL 9003. Other colours on request.
- Models up to LEX 12 fitted with hinged interchangeable side plates for easy access, LEX 14 and up with easy removable side plates.
- All models equipped with splash guard.
- Available with electric defrost in coil and driptray, or hot gas coil in driptray.
- Equipped with a Schrader valve on the suction connection for testing purposes.
- Sufficient room for fitting the expansion valve inside.
- Stickers indicate fan direction and refrigerant in/out.
- Heavy duty packing in boxes or crates. LEX 18 and up delivered on wooden beams in mounting position.
- All models available on request for pumped circulation and glycol.

## Two Year Full Guarantee

Helpman only use high grade materials for all coolers and condensers, thus ensuring a remarkably long life. Helpman can therefore offer a full two year guarantee on all equipment.

## Fans and Fan Motors

Fans with aluminium fan blades, fitted with robust epoxy coated fan guards in anti-vibration mountings. Enclosed design fan motors, protection class IP55. All motors with terminal box with 2 cable inlets Pg 13.5. Motors are equipped with a thermal safety device built in the windings, connected to separate terminals in the box. This safety device can therefore be integrated into the control circuit.

The electrical control should be arranged preferably with a manual reset device in order to prevent continuous on/off switching (tripping) of the motors.

The single phase (220/1) motors are suitable for 220-240 V, 50 Hz, 1 phase supply.

The three phase (380/3) motors are suitable for 220-240 / 380-415 V, 50 Hz, 3 phase supply. 60 Hz models on request.

## Defrost

## Heavy Duty Electric Defrost

Stainless steel heater elements placed in additional tubes between the evaporator tubes. The elements for the driptray are fitted to the bottom of the innertray. Both coil and driptray have the same elements. Voltage : 220-240/1.

Coolers equipped with 3 or multiple of 3 elements are suitable for 220-240/1, 220-240/3 or 380-415/3 supply when connected either in delta or star.

All elements can be withdrawn at the refrigerant connection side. The driptray elements can be taken out after removal of the outertray.

Heater elements are connected to a terminal box. Electric defrost is indicated with **E**, e.g. **LEX 24 - 7 E**.

For reduced defrosting power (75 %, 6 or multiple of 6 elements only) see below.

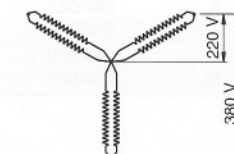

Standard

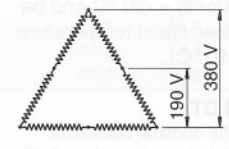
Reduced defrost  
(re-wiring of heaters to be done in terminal box).

## Hot-gas defrost

Copper coil fitted to the bottom of the innertray. This execution is indicated as **G**, e.g. **LEX 24 - 7 G**.

## Corrosion protection

For application in aggressive cooling environments coolers are available with a fully coated coil block (by submersion).

This execution is indicated as **C**, e.g. **LEX 24 - 7 C**.

**Note !** Execution C is not possible for LEX 30 and generally not in combination with electric defrost E.

Fins of prepainted aluminium (Goldlack) on request.

# Blow Through Unit Coolers

1.5 - 40 kW

LEX

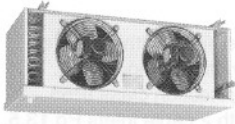

## Nominal Capacities (kW)

| Cooler type             | R 22 frosted DT <sub>1</sub> | R 134a frosted DT <sub>1</sub> | R 404A frosted DT <sub>1</sub> | For reference only dry conditions DT <sub>1</sub> |        |        |
|-------------------------|------------------------------|--------------------------------|--------------------------------|---|--------|--------|
|                         |                              |                                |                                | R 22  | R 134a | R 404A |
| <b>Fin spacing 4 mm</b> |                              |                                |                                |   |        |        |
| LEX 2-4                 | 1.5                          | 1.3                            | 1.5                            | 1.3   | 1.1    | 1.3    |
| LEX 4-4                 | 1.9                          | 1.5                            | 1.8                            | 1.7   | 1.3    | 1.6    |
| LEX 6-4                 | 2.8                          | 2.4                            | 2.8                            | 2.4   | 2.1    | 2.5    |
| LEX 8-4                 | 4.7                          | 4.1                            | 4.7                            | 4.1   | 3.5    | 4.1    |
| LEX 10-4                | 4.7                          | 4.4                            | 4.8                            | 4.1   | 3.8    | 4.2    |
| LEX 12-4                | 5.9                          | 5.6                            | 6.2                            | 5.1   | 4.9    | 5.4    |
| LEX 14-4                | 6.5                          | 6.4                            | 7.1                            | 5.7   | 5.6    | 6.2    |
| LEX 16-4                | 8.7                          | 8.4                            | 9.3                            | 7.5   | 7.3    | 8.1    |
| LEX 18-4                | 9.7                          | 8.7                            | 9.8                            | 8.5   | 7.6    | 8.6    |
| LEX 20-4                | 12.8                         | 10.8                           | 12.7                           | 11.2  | 9.4    | 11.0   |
| LEX 22-4                | 16.1                         | 13.0                           | 15.4                           | 14.0  | 11.3   | 13.4   |
| LEX 24-4                | 20.0                         | 16.1                           | 19.2                           | 17.4  | 14.0   | 16.7   |
| LEX 26-4                | 26.0                         | 23.0                           | 26.0                           | 22.6  | 20.0   | 22.6   |
| LEX 28-4                | 32.8                         | 29.0                           | 33.2                           | 28.5  | 25.2   | 28.9   |
| LEX 30-4                | 40.3                         | 32.5                           | 38.5                           | 35.0  | 28.3   | 33.4   |

## Fin spacing 7 mm

|          |      |      |      |      |      |      |
|----------|------|------|------|------|------|------|
| LEX 2-7  | 1.3  | 1.2  | 1.3  | 1.1  | 1.0  | 1.2  |
| LEX 4-7  | 1.7  | 1.4  | 1.7  | 1.5  | 1.2  | 1.4  |
| LEX 6-7  | 2.5  | 2.2  | 2.5  | 2.2  | 1.9  | 2.2  |
| LEX 8-7  | 4.1  | 3.7  | 4.3  | 3.6  | 3.3  | 3.7  |
| LEX 10-7 | 3.7  | 3.6  | 4.0  | 3.2  | 3.2  | 3.5  |
| LEX 12-7 | 5.0  | 4.9  | 5.3  | 4.4  | 4.3  | 4.6  |
| LEX 14-7 | 5.5  | 5.5  | 6.0  | 4.8  | 4.8  | 5.2  |
| LEX 16-7 | 7.4  | 7.3  | 8.0  | 6.4  | 6.3  | 7.0  |
| LEX 18-7 | 8.5  | 7.8  | 8.8  | 7.4  | 6.8  | 7.6  |
| LEX 20-7 | 11.4 | 10.0 | 11.4 | 9.9  | 8.7  | 9.9  |
| LEX 22-7 | 14.5 | 12.4 | 14.3 | 12.6 | 10.7 | 12.4 |
| LEX 24-7 | 18.1 | 15.6 | 17.8 | 15.7 | 13.5 | 15.5 |
| LEX 26-7 | 22.8 | 21.2 | 23.4 | 19.8 | 18.4 | 20.4 |
| LEX 28-7 | 28.5 | 26.5 | 29.3 | 24.8 | 23.0 | 25.5 |
| LEX 30-7 | 36.5 | 31.0 | 35.9 | 31.7 | 27.0 | 31.2 |

## Capacities

### Frosted Conditions

- Lightly frosted coil.
- Relative humidity 85 %
- Suction gas superheating 62 % of the temperature difference (DT<sub>1</sub>), with a minimum of 3.5 K
- Refrigerant liquid temperature 30 °C (for t<sub>0</sub> = -20 °C and below; liquid temperature 10 °C).

### DT<sub>1</sub>

The nominal capacities stated, are based on -8 °C evaporating temperature (t<sub>0</sub>) and 8 K difference between air-on and evaporating temperature. (ENV 328, Condition II)

### t<sub>0</sub>

Evaporating temperature t<sub>0</sub> is the saturated temperature according to the pressure at the suction outlet of the cooler.

## Dry Conditions

Cooling capacity where no condensation or ice build-up occurs on the coil (100% sensible cooling). This condition is used by Cecomaf to standardise capacity ratings but should not be used when selecting coolers.

## Correction Factors R 404A / DT<sub>1</sub>

| DT <sub>1</sub> | Evaporating Temperature (t <sub>0</sub> ) °C |      |      |      |      |      |      |      |      |      |     |
|-----------------|--|------|------|------|------|------|------|------|------|------|-----|
|                 | K  | +5   | 0    | -5   | -8   | -10  | -15  | -20  | -25  | -30  | -35 |
| 6               | 1.22   | 1.32 | 1.41 |      | 1.48 | 1.54 | 1.60 | 1.65 | 1.70 | 1.77 |     |
| 7               | 1.01   | 1.09 | 1.17 |      | 1.24 | 1.30 | 1.36 | 1.41 | 1.47 | 1.54 |     |
| 8               | 0.85   | 0.92 | 0.97 | 1.00 | 1.03 | 1.12 | 1.18 | 1.23 | 1.29 | 1.37 |     |
| 9               | 0.73   | 0.80 | 0.86 |      | 0.92 | 0.98 | 1.03 | 1.09 | 1.16 | 1.24 |     |
| 10              | 0.64   | 0.70 | 0.75 |      | 0.81 | 0.87 | 0.92 | 0.98 | 1.05 | 1.13 |     |
| 11              | 0.56   | 0.61 | 0.67 |      | 0.72 | 0.77 | 0.83 | 0.89 | 0.96 | 1.05 |     |

## Correction Factors R 22 / DT<sub>1</sub>

| DT <sub>1</sub> | Evaporating Temperature (t <sub>0</sub> ) °C |      |      |      |      |      |      |      |     |     |     |
|-----------------|--|------|------|------|------|------|------|------|-----|-----|-----|
|                 | K  | +5   | 0    | -5   | -8   | -10  | -15  | -20  | -25 | -30 | -35 |
| 6               | 1.10   | 1.20 | 1.31 |      | 1.42 | 1.53 | 1.62 | 1.66 |     |     |     |
| 7               | 0.93   | 1.01 | 1.11 |      | 1.22 | 1.32 | 1.40 | 1.46 |     |     |     |
| 8               | 0.80   | 0.88 | 0.95 | 1.00 | 1.05 | 1.16 | 1.24 | 1.30 |     |     |     |
| 9               | 0.70   | 0.77 | 0.85 |      | 0.94 | 1.03 | 1.12 | 1.18 |     |     |     |
| 10              | 0.61   | 0.68 | 0.76 |      | 0.84 | 0.93 | 1.02 | 1.09 |     |     |     |
| 11              | 0.55   | 0.61 | 0.68 |      | 0.76 | 0.85 | 0.94 | 1.01 |     |     |     |

## Correction Factors R 134a / DT<sub>1</sub>

| DT <sub>1</sub> | Evaporating Temperature (t <sub>0</sub> ) °C |      |      |      |      |      |      |      |      |      |     |
|-----------------|--|------|------|------|------|------|------|------|------|------|-----|
|                 | K  | +5   | 0    | -5   | -8   | -10  | -15  | -20  | -25  | -30  | -35 |
| 6               | 1.10   | 1.23 | 1.35 |      | 1.44 | 1.52 | 1.57 | 1.63 | 1.69 | 1.79 |     |
| 7               | 0.93   | 1.05 | 1.15 |      | 1.23 | 1.30 | 1.36 | 1.41 | 1.48 | 1.57 |     |
| 8               | 0.81   | 0.90 | 0.97 | 1.00 | 1.05 | 1.14 | 1.19 | 1.25 | 1.31 | 1.41 |     |
| 9               | 0.71   | 0.80 | 0.88 |      | 0.95 | 1.01 | 1.07 | 1.12 | 1.19 | 1.28 |     |
| 10              | 0.63   | 0.71 | 0.78 |      | 0.85 | 0.91 | 0.97 | 1.02 | 1.09 | 1.18 |     |
| 11              | 0.56   | 0.64 | 0.71 |      | 0.77 | 0.83 | 0.88 | 0.94 | 1.01 | 1.10 |     |

# Blow Through Unit Coolers 1.5 - 40 kW

**LEX**

## Dimensions / Connections

| Cooler type | Dimensions mm |      |     |     |     |     |      | Shipp. vol. m <sup>3</sup> | Cooler weight |         | Coil surface        |                     | Int. vol. dm <sup>3</sup> | Refrig. conn. |                |
|-------------|---------------|------|-----|-----|-----|-----|------|----------------------------|---------------|---------|---------------------|---------------------|---------------------------|---------------|----------------|
|             | A             | B    | D   | F   | G   | H   | K    |                            | 4 mm kg       | 7 mm kg | 4 mm m <sup>2</sup> | 7 mm m <sup>2</sup> |                           | inlet O.D.    | suction O.D.S. |
| LEX 2 - •   | 598           | 412  | 465 | 365 | -   | 360 | 380  | 0.3                        | 18            | 17      | 7.7                 | 4.7                 | 2.1                       | ½"            | ½"             |
| LEX 4 - •   | 658           | 472  | 495 | 395 | -   | 430 | 440  | 0.3                        | 22            | 21      | 11.2                | 6.7                 | 3.0                       | ½"            | ½"             |
| LEX 6 - •   | 658           | 472  | 605 | 503 | -   | 430 | 440  | 0.3                        | 27            | 25      | 16.8                | 10.1                | 4.0                       | ½"            | 5/8"           |
| LEX 8 - •   | 788           | 602  | 640 | 503 | -   | 505 | 570  | 0.6                        | 38            | 35      | 26.1                | 15.7                | 6.0                       | ½"            | 22 mm          |
| LEX 10 - •  | 1106          | 920  | 495 | 395 | -   | 430 | 880  | 0.5                        | 35            | 32      | 22.4                | 13.5                | 6.0                       | ½"            | 22 mm          |
| LEX 12 - •  | 1106          | 920  | 605 | 503 | -   | 430 | 880  | 0.5                        | 42            | 38      | 33.6                | 20.2                | 6.8                       | ½"            | 28 mm          |
| LEX 14 - •  | 970           | 692  | 710 | 520 | 35  | 600 | 660  | 0.6                        | 50            | 46      | 35.2                | 21.2                | 8.0                       | ½"            | 28 mm          |
| LEX 16 - •  | 1110          | 792  | 750 | 520 | 35  | 675 | 760  | 0.7                        | 65            | 61      | 46.4                | 27.9                | 10.4                      | ½"            | 28 mm          |
| LEX 18 - •  | 1460          | 1180 | 690 | 500 | 35  | 520 | 1140 | 1.0                        | 71            | 65      | 52.2                | 31.4                | 11.6                      | ½"            | 35 mm          |
| LEX 20 - •  | 1640          | 1360 | 710 | 520 | 35  | 600 | 1320 | 1.3                        | 95            | 88      | 70.5                | 42.4                | 15.5                      | 5/8"          | 35 mm          |
| LEX 22 - •  | 1880          | 1560 | 750 | 520 | 35  | 675 | 1520 | 1.7                        | 120           | 111     | 92.8                | 55.9                | 20.4                      | 5/8"          | 42 mm          |
| LEX 24 - •  | 1880          | 1560 | 950 | 630 | 110 | 825 | 1520 | 2.2                        | 139           | 128     | 116.0               | 69.8                | 28.2                      | 5/8"          | 42 mm          |
| LEX 26 - •  | 2650          | 2328 | 750 | 520 | 35  | 675 | 2290 | 2.3                        | 172           | 159     | 139.8               | 84.2                | 30.9                      | 5/8"          | 54 mm          |
| LEX 28 - •  | 2650          | 2328 | 920 | 630 | 110 | 825 | 2290 | 3.0                        | 202           | 186     | 174.7               | 105.2               | 39.8                      | 5/8"          | 54 mm          |
| LEX 30 - •  | 3420          | 3098 | 920 | 630 | 110 | 825 | 3050 | 3.9                        | 278           | 256     | 232.7               | 140.1               | 51.1                      | 5/8"          | 54 mm          |

**LEX**

## Fans / Electric Defrost

| Cooler type | Fans 50 Hz |              |                        |                        |                          |                                |   | Electric defrost |                    |          |                            |            |  |
|-------------|------------|--------------|------------------------|------------------------|--------------------------|--------------------------------|---|------------------|--------------------|----------|----------------------------|------------|--|
|             | number     | dia-meter mm | air volume fin spacing |                        | air <sup>2</sup> throw m | sound <sup>3</sup> level dB(A) | fan power nominal / absorbed <sup>4</sup> |                  | number of elements |          | defrost power <sup>5</sup> |            |  |
|             |            |              | 4 mm m <sup>3</sup> /h | 7 mm m <sup>3</sup> /h |                          |                                | 220/1 W                                   | 380/3 W          | coil               | driptray | kW                         | reduced kW |  |
| LEX 2 - •   | 1          | 254          | 1030                   | 1080                   | 10                       | 48                             | 30/80                                     | 30/65            | 1                  | 1        | 1.28                       | -          |  |
| LEX 4 - •   | 1          | 305          | 1490                   | 1570                   | 12                       | 50                             | 30/100                                    | 30/100           | 1                  | 1        | 1.76                       | -          |  |
| LEX 6 - •   | 1          | 305          | 1420                   | 1500                   | 12                       | 50                             | 30/100                                    | 30/100           | 2                  | 1        | 2.64                       | -          |  |
| LEX 8 - •   | 1          | 356          | 2490                   | 2620                   | 15                       | 53                             | 70/160                                    | 90/145           | 2                  | 1        | 3.0                        | -          |  |
| LEX 10 - •  | 2          | 305          | 2970                   | 3130                   | 15                       | 53                             | 30/100                                    | 30/100           | 1                  | 1        | 3.2                        | -          |  |
| LEX 12 - •  | 2          | 305          | 2860                   | 3010                   | 15                       | 53                             | 30/100                                    | 30/100           | 2                  | 1        | 4.8                        | -          |  |
| LEX 14 - •  | 1          | 406          | 3360                   | 3540                   | 15                       | 57                             | 70/230                                    | 90/215           | 5                  | 1        | 4.5                        | 3.4        |  |
| LEX 16 - •  | 1          | 457          | 4430                   | 4660                   | 20                       | 60                             | 220/380                                   | 250/400          | 5                  | 1        | 6.0                        | 4.5        |  |
| LEX 18 - •  | 2          | 356          | 4980                   | 5240                   | 20                       | 56                             | 70/160                                    | 90/145           | 2                  | 1        | 5.4                        | -          |  |
| LEX 20 - •  | 2          | 406          | 6730                   | 7080                   | 20                       | 60                             | 70/230                                    | 90/215           | 5                  | 1        | 8.4                        | 6.3        |  |
| LEX 22 - •  | 2          | 457          | 8850                   | 9320                   | 20                       | 63                             | 220/380                                   | 250/400          | 5                  | 1        | 13.2                       | 9.9        |  |
| LEX 24 - •  | 2          | 508          | 11000                  | 11600                  | 20                       | 66                             | 220/430                                   | 250/480          | 5                  | 1        | 13.2                       | 9.9        |  |
| LEX 26 - •  | 3          | 457          | 13000                  | 14000                  | 20                       | 65                             | 220/380                                   | 250/400          | 5                  | 1        | 19.2                       | 14.4       |  |
| LEX 28 - •  | 3          | 508          | 16600                  | 17500                  | 20                       | 68                             | 220/430                                   | 250/480          | 5                  | 1        | 19.2                       | 14.4       |  |
| LEX 30 - •  | 4          | 508          | 22200                  | 23400                  | 20                       | 69                             | 220/430                                   | 250/480          | 10                 | 2        | 24.0                       | 18.0       |  |

1) LEX 30 :  
3 mounting channels, dist. ½ B = 1549 mm  
2 water drains, 1" BSP male, distance 1700 mm

2) Air throw at t = 20 °C.  
Minimum air velocity = 0.25 m/s.

3) Sound levels are the results of tests carried out in free field conditions. The values are measured in the horizontal plane at a distance of 5 meter with an A-filter. Values may deviate depending on situations at site.

4) Fan power is given per motor. Absorbed fan power is measured with coil face area blocked for 75 % and ambient temperature 20 °C.

5) Total defrost power is based on 220 V.  
For 240 V this value increases by 20 %.

LEX 2 - 12

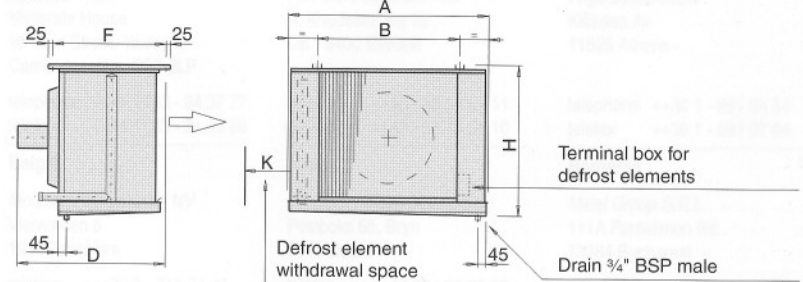

LEX 14 - 30

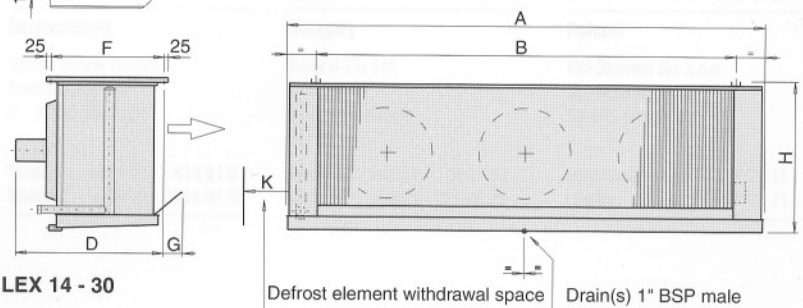

# Blow Through Unit Coolers 1.5 - 40 kW

LEX

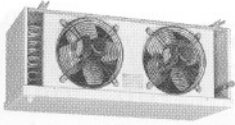

### Overload Relays

For installations equipped with motor switches with thermal overload relays the following points are essential :  
 In the fan data tables the motor power as given on the name plate of the motor is listed.  
 As the fan motor on a cooler is intensively cooled by the air flow it is possible to load the motor over its nominal power. The maximum allowable Amps are given on the motor name plate.  
 In the table below the overload relay settings are listed for various ambient temperatures.  
 These values are valid for a frosted coil with the face area blocked for 75 %.

#### Adjustment values for overload relays (50 Hz, nom. 1500 rpm)

| t<br>°C | 220-240/50/1 |       |       |       |       |       |
|---------|--------------|-------|-------|-------|-------|-------|
|         | 30 W         |       | 70 W  |       | 220 W |       |
|         | 220 V        | 240 V | 220 V | 240 V | 220 V | 240 V |
| 0       | 0.49         | 0.51  | 1.22  | 1.20  | 2.54  | 2.64  |
| -20     | 0.51         | 0.53  | 1.27  | 1.24  | 2.73  | 2.81  |
| -40     | 0.54         | 0.55  | 1.35  | 1.35  | 2.82  | 2.88  |

| t<br>°C | 220-240/380-415/50/3 |      |       |       |      |
|---------|----------------------|------|-------|-------|------|
|         | 30 W                 |      |       |       |      |
|         | 220 V                | Δ    | 240 V | 380 V | Y    |
| 0       | 0.42                 | 0.46 |       | 0.24  | 0.26 |
| -20     | 0.45                 | 0.48 |       | 0.26  | 0.28 |
| -40     | 0.47                 | 0.49 |       | 0.27  | 0.29 |

| t<br>°C | 90 W  |      |       |       |      |
|---------|-------|------|-------|-------|------|
|         | 220 V | Δ    | 240 V | 380 V | Y    |
|         | 0     | 0.86 | 0.88  |       | 0.50 |
| -20     | 0.90  | 0.92 |       | 0.52  | 0.53 |
| -40     | 0.95  | 0.97 |       | 0.55  | 0.56 |

| t<br>°C | 250 W |      |       |       |      |
|---------|-------|------|-------|-------|------|
|         | 220 V | Δ    | 240 V | 380 V | Y    |
|         | 0     | 1.87 | 1.87  |       | 1.08 |
| -20     | 1.98  | 1.91 |       | 1.14  | 1.10 |
| -40     | 2.13  | 1.94 |       | 1.23  | 1.12 |

### Optional Features

#### ■ Klixon Switch

The Klixon switch is used for coolers fitted with electric defrost to reduce the defrost time. This gives higher defrost efficiency and saves running costs.  
 The switch opens at +12 °C ( ± 3 K ) and terminates the defrost period. In the cooling cycle the switch closes at -5 °C ( ± 3 K ). The Klixon-switch can only be used when room temperature is below -10 °C. Switch capacity is 5 A at 240 V (non inductive), cable length 500 mm.

#### ■ Supports for Wall Mounting

Supports for wall mounting are delivered in sets comprising 2 or 3 supports with associated 4 or 6 special bolts, nuts and washers for mounting the cooler to the supports. Type B 30 is for mounting the vertical leg behind the insulation.

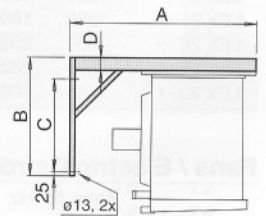

| Type | Cooler model     | Dimensions mm |     |     |    |
|------|------------------|---------------|-----|-----|----|
|      |                  | A             | B   | C   | D  |
| B 10 | LEX 2, 4 and 10  | 603           | 504 | 355 | 30 |
| B 20 | LEX 2 - LEX 22   | 853           | 704 | 500 | 75 |
| B 30 | LEX 2 - LEX 30 * | 1103          | 704 | 500 | 75 |

\* For LEX 30 a set of 3 supports is required.

#### ■ Fan ring heater

When air coolers are to operate under humid working conditions, fan ring heaters can be used to prevent fans from jamming by ice or frost build up. Fan ring heaters are available for all models with fans ø 406, 457 or 508 mm.

#### ■ Hinged driptray

For all models a hinged driptray construction for easy access and cleaning purposes is optional.

#### ■ Water Drain Connections

Brass elbow,  
 2 x ¼" BSP female.  
 Article no.: 26 26 18



#### ■ Re-heating Elements XR / HR

At low ambient temperatures the humidity in the cold room may become too high due to a short running time of the compressor.  
 With the use of an electric heater in association with the fans running, the room temperature rises and the compressor will start. Under these conditions the humidity of the air in the room can be reduced.

Re-heating elements are available in two executions:  
 - Finned Tube Heating Elements (XR)  
 - Smooth Tube Heating Elements (HR)



### Eflo Refrigerant Circuiting

The optimal use of the available heat exchanging surface by means of "EFLO" liquid distribution system is based on two principles :

- The refrigerant is evaporating through the coil in parallel flow with the air.
- Superheating takes place on the air-inlet side, in the area with the highest tube temperature.

With EFLO, the cooling performance improves as a result of :

- Even frost formation over the coil.
- Prolongued cooling cycle, therefore a higher effective cooling capacity.
- Shorter defrost cycle.

- 1: Refrigerant inlet temperature.
- 2: Beginning of superheating refrigerant vapour.
- 3: Evaporating temperature (to) corresponding with the pressure at the outlet of the cooler.
- 4: Superheating temperature.
- 5: Air-inlet temperature.
- 6: Air-outlet temperature.

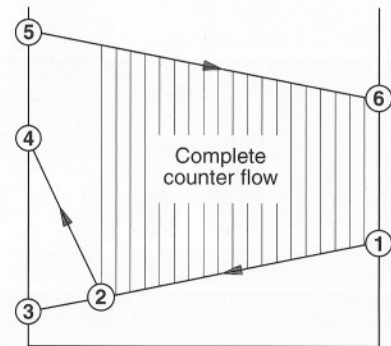
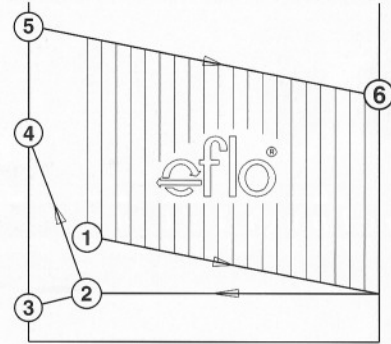

#### Factory and Head Office

Apparatenfabriek Helpman BV  
Postbus 44  
NL 9700 AA Groningen  
Peizerweg 97

telefoon ++31 50 - 521 75 55  
telefax ++31 50 - 526 48 78  
E-mail info@helpman.nl  
internet www.helpman.nl

#### Bulgaria

Helpman Sofia EOOD  
89, Tzar Boris III Bld.  
1612 Sofia

telefoon ++359 2 - 581 52 98  
telefax ++359 2 - 581 52 98

#### United Kingdom

APS Ltd.  
Meliorate House  
98 Main Street, Yaxley  
Cambridgeshire, PE7 3LP

telefoon ++44 1733 - 24 37 77  
telefax ++44 1733 - 24 38 88

#### België

Molimex-Refrigeration NV  
Vierwinden 6  
1930 Zaventem

telefoon ++32 2 - 715 24 44  
telefax ++32 2 - 725 22 26

#### Deutschland

Schick Emzet GmbH  
Postfach 301049  
D - 70450 Stuttgart

Telefon ++49 711 - 814 91 0  
Telefax ++49 711 - 814 91 30

#### Ireland

HRP Wholesale.  
100 Slaney Road,  
Dublin, Ind. Estate,  
Finglas, Dublin 11

telefoon ++353 1 - 830 65 65  
telefax ++353 1 - 830 61 53

#### Danmark

AIR-CON Danmark A/S  
A. Knudsens Vej 15  
DK - 8400 Ebeltoft

telefoon ++45 - 86 34 51 11  
telefax ++45 - 86 34 58 10

#### Norge

Schlösser Møller Kulde A/S  
Postboks 65, Bryn  
0611 Oslo-6

telefoon ++47 22 - 64 65 60  
telefax ++47 22 - 64 65 77

#### Hungary

Soós & Co. Ltd.  
P.O. Box 94  
H-1631 Budapest  
Czirákí út 5-7

telefoon ++36 1 - 114 97 93  
telefax ++36 1 - 221 46 79

#### Turkey

Sogusan Ltd. Sti.  
Necatibey Cad. Gayret Han 69  
209 - 11 Karaköy  
Istanbul

telefoon ++90 1 - 293 76 48  
telefax ++90 1 - 293 71 10

#### Greece

Frigo Systems SA  
Kifissias Av.  
11525 Athens

telefoon ++30 1 - 691 04 54  
telefax ++30 1 - 691 07 64

#### Romania

Midal Group S.R.L.  
111A Pantelimon Rd.  
73384 Bucharest

telefoon ++40 1 - 312 35 03  
telefax ++40 1 - 312 31 05

#### Poland

Pol-Stowest Sp. z.o.o.  
Ul. Klimasa 46  
50-515 Wroclaw

telefoon ++48 71 - 67 75 11  
telefax ++48 71 - 67 75 11